

平拨型&直角型&琴键型DIP开关

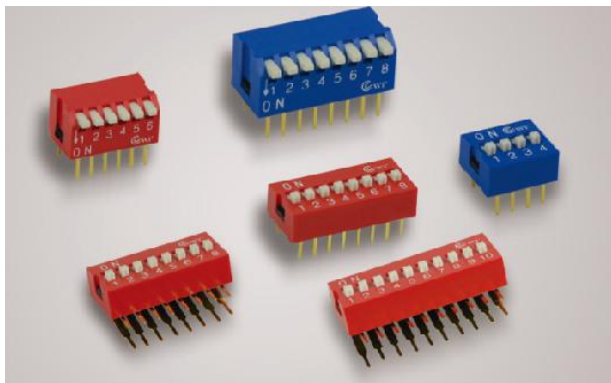

机械性能

MECHANICAL

操作力:800g Max
 推钮行程:0.90 mm
 使用温度:-20°C ~ +70°C
 储存温度:-40°C ~ +85°C

Operation Force: 800g Max
 Stroke: 0.90mm
 Operation Temp: -20°C ~ +70°C
 Storage Temp: -40°C to 85°C

材料

MATERIALS

底座:工程塑料,黑色
 上盖:工程塑料,黑色,红色,蓝色
 推钮:工程塑料,白色
 端子:合金铜镀金

Base: Engineering Plastics,Black
 Cover: Engineering Plastics,Black,Red,Blue
 Button: Engineering Plastics,White
 TERMINAL: Alloy Copper,Gold plating

电器性能

ELECTRICAL

电器寿命:在电压24VDC与电流25mA之下测试,可来回拨动2000次。
 开关不经常切换的额定电流:100mA,耐压50VDC。
 开关经常切换的额定电流:25mA,耐压24VDC。
 接触阻抗:初始值最大值50mΩ;测试后最大值100mΩ。
 绝缘阻抗:最小100MΩ,500VDC。
 耐压强度:500VAC/1分钟。
 极际电容:最大5pF。
 回路:单接点单选择。

Electrical Life: 2000 operations cycles per switch
 Non-Switching Rating: 100mA,50VDC
 Switching rating: 25mA,24VDC
 Contact resistance: 50mΩ max.at initial;100mΩ max.after life test
 Insulation Resistance: 100MΩ,500VDC
 Dielectrice Strength: 500VAC/1 minute
 Capacitance: 5pF max
 Circuit: Single pole single throw

焊接和清洗过程

SOLDERING AND CLEANING PROCESSES

在所有操作过程中,请确保开关在"off"位置。
 波峰焊:推荐焊锡温度在260°C,最多5秒钟。
 手工焊:使用30瓦烙铁控制温度在320°C,焊接时间大约2秒钟。
 清洗过程:清洗使用超音波方式,能给予更好效果;使用蒸汽清洗时,温度不可超过51°C。

Keep all switch contacts in their "OFF" position for all operations
 Wave soldering: Recommended Solder Temperature at 260°C max.5 seconds
 Hand Soldering: Use a soldering iron of 30 watts,controlled at 320°C approx.2 sec. while applying solder.
 Cleaning Process: Flux clean using force rinse,high agitation or triple bath cleaning method. Freon TF or TE give excellent results.
 When vapormethods are used do not subject the switch to solvents at temperature above 51 °C.

包装 PACKAGE

HOW TO ORDER 产品订购信息

以上产品皆以IC管形式包装
 All DIP Switches are shipped in standar IC tube

系列 SERIES	开关位数 NO. OF POS	每管数量 PER TURE	每盒数量 PER BOX	外箱包装及数量 PER CTN
DS	2	70PCS	4200PCS	4 boxes (53.5x28x21.5CM)
DS	3	51PCS	3060PCS	
DS	4	40PCS	2400PCS	
DS	5	33PCS	1980PCS	
DS	6	28PCS	1680PCS	6 boxes (53.5x28x32CM)
DS	7	24PCS	1440PCS	
DS	8	21PCS	1260PCS	8 boxes (53.5x28x41.5CM)
DS	9	19PCS	1140PCS	
DS	10	17PCS	1020PCS	
DS	12	14PCS	840PCS	

系列 SERIES	开关位数 NO. OF POS	每管数量 PER TURE	每盒数量 PER BOX	外箱包装及数量 PER CTN
DA/DP	2	58PCS	3480PCS	4 boxes (44.5x29x23.5CM)
DA/DP	3	42PCS	2520PCS	
DA/DP	4	33PCS	1980PCS	
DA/DP	5	27PCS	1620PCS	
DA/DP	6	23PCS	1380PCS	6 boxes (48x30x37CM)
DA/DP	7	20PCS	1200PCS	
DA/DP	8	17PCS	1020PCS	
DA	9	16PCS	960PCS	
DA/DP	10	14PCS	840PCS	
DA/DP	12	12PCS	720PCS	

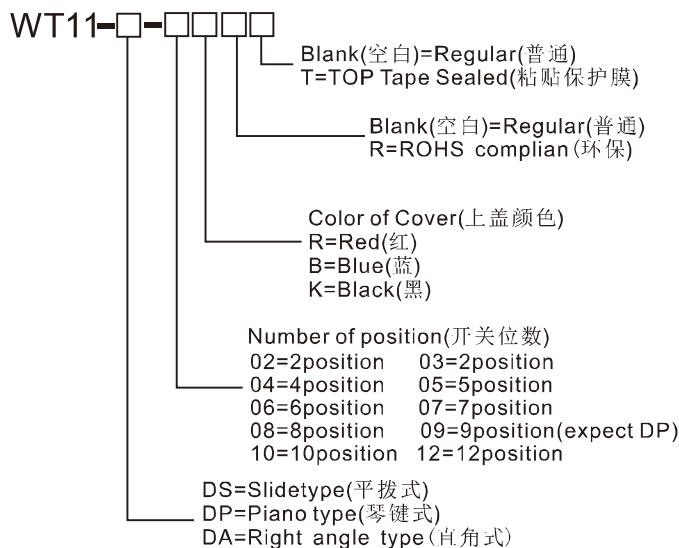

SLIDE&RIGHT-ANGLE&PIANO TYPE



平拨型&直角型&琴键型DIP开关

DS TYPE 平拨型

unit:mm

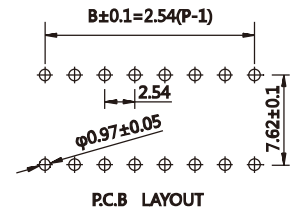
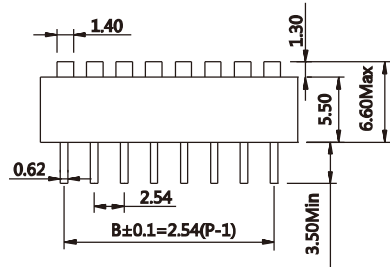
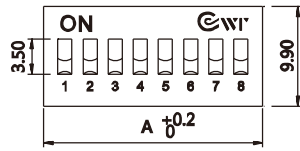
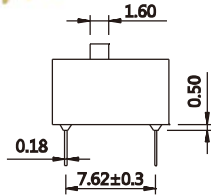
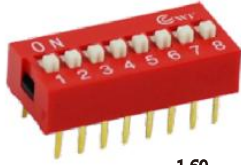

DP TYPE 琴键型

unit:mm

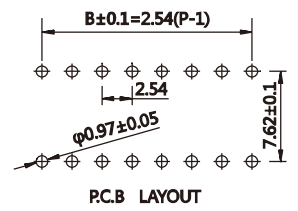
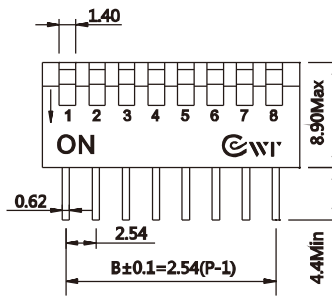
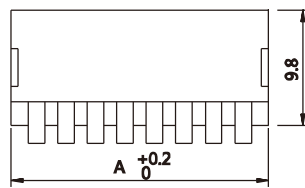
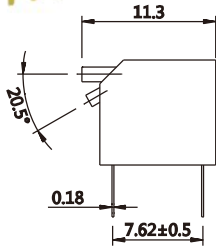

DA TYPE 直角型

unit:mm

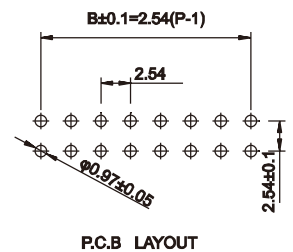
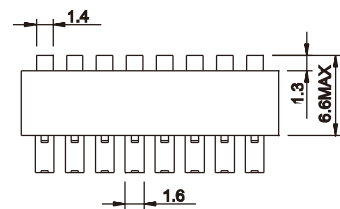
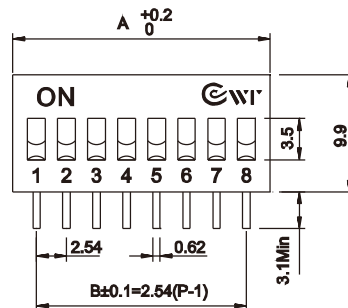
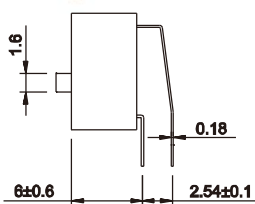
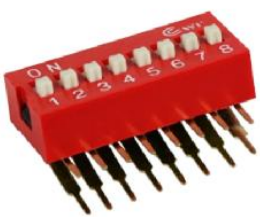

位数 Positions(P)	2P	3P	4P	5P	6P	7P	8P	9P	10P	12P
长度 DIM.A(mm)	6.54	9.08	11.62	14.16	16.70	19.24	21.78	24.32	26.88	31.94